

*Casio DT-930  
and standard program  
Users Manual*



---

**Data Technology**  
Hardware • Software  
Design • Consulting

ASP Microcomputers  
456 North Road,  
Ormond, Victoria, 3204  
Australia  
Telephone: (03) 9578-7600  
FAX: (03) 9578-7727  
email: [solutions@asp.com.au](mailto:solutions@asp.com.au)  
World Wide Web: <http://www.asp.com.au>

(ASP Microcomputers is a division of Grayline Holdings Pty. Ltd., A.C.N. 004 940 729)

Version 1 – September 29<sup>th</sup>, 2008

Copyright © 2008 by ASP Microcomputers  
Some content © 2008 by Casio

The ASP logo is a trademark of ASP Microcomputers  
The Casio logo is a trademark of Casio Japan



# Contents

Welcome to the Casio DT-930 .....	1
First Things First .....	2
DT-930 Terminal Overview .....	2
HA-E6Ø IO Cradle Overview .....	3
Batteries .....	4
Important Information .....	4
Turning the DT-930 On and Off .....	4
Using the Standard Data Collection program .....	5
The Main Menu .....	5
Collect Data .....	5
Download Data .....	6
Configuration .....	7
About .....	9
Scanning Barcodes .....	9
Keypad Input .....	9
Screen Symbols .....	10
Low Battery Indicators .....	10
Auto Off .....	10
Display and Keypad Backlight .....	11
Casio Download/Upload Utility .....	11
Installing the Download/Upload Utility and Drivers .....	13
Copyright, License, and Limited Warranty .....	16



ASP Microcomputers is an authorised Casio Partner



## Welcome to the Casio DT-930

The DT-930 is a high-performance data collection terminal with laser barcode scanner, which includes the following features:

### General

- Built-in high performance laser scanner
- Long battery life
- Powered by two AA Alkaline batteries
- Rechargeable lithium-ion battery option available
- Large bright display
- Backlit keypad and display
- Three colour LED indicator

### Communicates via IrDA or Bluetooth

- High speed infrared communication with IrDA version 1.1
- Bluetooth® version 1.2

### Small size and light weight means improved portability

- Dimensions: Approx. 69 (w) x 180 (d) x 40.2 (h) mm
- Weight: Approx. 225 g (with AA batteries fitted).

### Improved durability

- Drop durability: 1.8 m in height
- Dust and water-splash proof to IP54 level (compliant with IEC529 International Standard)

### Scans all common barcode symbologies

- EAN8, EAN13, UPC-A/E, CODABAR, CODE39, CODE93, CODE 128/ EAN128, ITF, MSI, IATA, Industrial 2 of 5

### Outstanding performance and large memory

- CPU: High-performance 32-bit RISC type
- RAM: 4 MB (user area 1.6 MB)
- FROM: 16 MB (user area 12.5 MB)

More information on the Casio DT-930 is available on our web site:

<http://www.asp.com.au/casio/dt930.html>

## First Things First

Before you can use your new Casio DT-930, you need to install some software on your PC. Turn to page 13 and follow the instructions there, then come back here to learn more about the DT-X7.

## DT-930 Terminal Overview

The diagrams and tables below and on the following page show the main features of the Casio DT-930 terminal and cradle.



## HA-E60 IO Cradle Overview

The diagrams and tables below and on the previous page show the main features of the **Casio HA-930 IO** cradle and terminal.

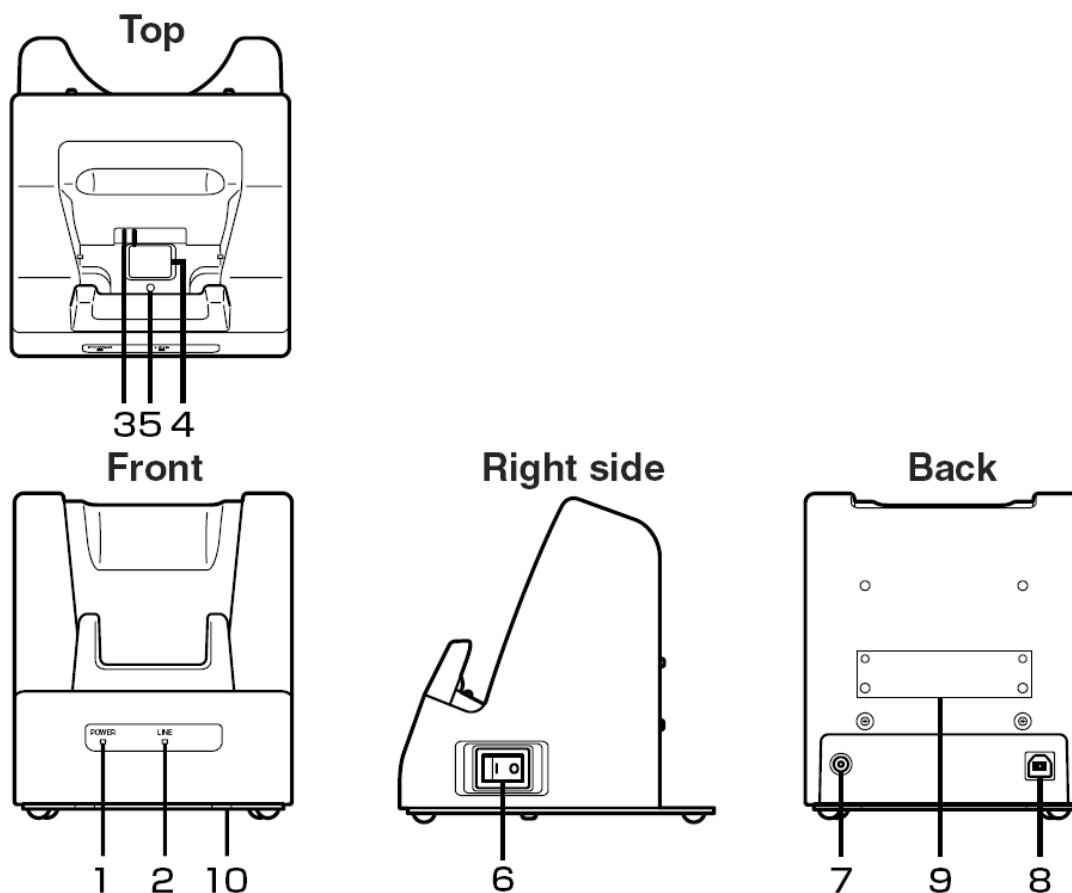

1	LED power indicator	Indicates the power status and whether the DT-930 is inserted. Off: Power is off Lit Green: Power is on and the DT-930 is correct inserted. Lit Red: Power is on and the DT-930 is not correctly inserted.
2	USB connection status	Indicates that the USB connection is operating correctly. Off: USB is not connected. On: USB is connected and operational.
3	Power supply terminal	Supplies power to the DT-930.
4	Infrared interface	Non-contact IR interface, used to communicate with the DT-930.
5	Terminal detection switch	Detects whether or not the DT-930 is inserted into the cradle correctly.
6	Power switch	Turns the cradle power on and off.
7	AC adaptor jack	For connection of the AC Adaptor (for use with the supplied AC adaptor only).
8	USB interface	For connection to a PC, for uploading/downloading of system and file data. Also allows power to be drawn from the PC. Note that the device driver must be installed on the PC before connecting the cradle to the PC – see page 13.
9	Wall mount unit attachment	Install the wall-mount unit with the wall mounting screws.
10	Desktop unit	Stand for using the cradle on a desktop. Remove it when mounting the cradle to a wall.

Note that the standard HA-930 IO cradle cannot recharge the optional lithium-ion battery pack – a **Casio DT-96x** series cradle is required.

## Batteries

The Casio DT-930 is powered by two AA-size alkaline batteries, and a lithium-ion rechargeable battery pack is available as an option. A CR-2032 lithium coin cell battery provides backup power while the main battery is removed. In this manual, the words “**main battery**” refer to either the alkaline batteries or the lithium-ion rechargeable battery pack, and the words “**backup battery**” refer to the CR-2032 lithium cell.

### Important Information

**Never** remove both the main battery and backup battery at the same time – doing so will cause all program settings and data to be lost or corrupted. Data **cannot** be recovered once it is lost or corrupted.

**Never** remove the main battery from the DT-930 while the power is turned on - doing so can cause data to be lost or corrupted. Make sure you turn the terminal off before removing the main battery.

Use **only** two AA-size alkaline batteries or the **correct** Casio lithium-ion battery pack. Do not use any other type of batteries.

When you do not plan to use your Casio DT-930 terminal for a long time, fit two new alkaline batteries to the unit to protect it from power failure during storage. Also, before you use the terminal after a long period of storage, fit two new alkaline batteries (or a fully charged lithium-ion battery pack) before use.

See page 10 for information on the DT-930’s low battery indicators.

### Turning the DT-930 On and Off

To turn the Casio DT-930 on, simply press the power button at the top right of the keypad (as shown on the left below, above the large **R** button) and hold it down until the display appears.

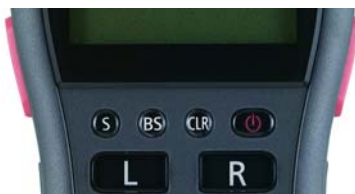

To turn the Casio DT-930 off, press the power button and hold it down until the display turns off. If the scanner does not turn off, release the button, wait a few seconds, then press and hold it down again.

## Using the Standard Data Collection program

Because the program loaded into the Casio DT-930 controls the way it works, it's difficult to describe operation of the unit without also describing the program. So, this section of the manual is based on ASP's standard Casio DT-930 Data Collection program. Most of the information presented will also apply to other programs, but you should also read any extra information supplied with your program.

### The Main Menu

Most programs behave in a similar way – there will usually be a **Main Menu**, where you can select what you want to do. With ASP's standard DT-930 Data Collection program, the **Main Menu** looks like this →

To select a function, press the number to the left of the function.

For the descriptions below, we'll assume that the program is set to its default of prompting for, and storing, just a barcode and a quantity.

We'll then explain the **Configuration** function, because it can affect how the program works.



### Collect Data

Press 1 at the Main Menu to select the **Collect Data** function. The display will now be similar to that shown on the right.

The middle of the screen shows an **Bar:** prompt. At this prompt, you can scan or type in a barcode number (see page 9 for more information).

As shown by the text near the bottom of the screen, pressing the **CLR** key at this prompt will take you back to the **Main Menu**.

Pressing the orange buttons on either side of the DT-930 will allow you to scan a barcode. The large **L** button will allow you to scan a barcode.



When you're scanning a barcode, a thin beam of red light will shine from the front of the unit – move this beam onto the barcode label, holding the unit about 3 to 30cm away from the label.

When the Casio DT-930 has read the barcode label successfully, a beep will sound and the indicator LED (above the display) will flash green briefly. See *Scanning Barcodes* on page 9 for more information on barcode scanning.

After you've scanned a barcode, or typed it in and pressed the **ENT** key, the next data collection screen is displayed (as shown on the right), where you're prompted to enter a quantity.

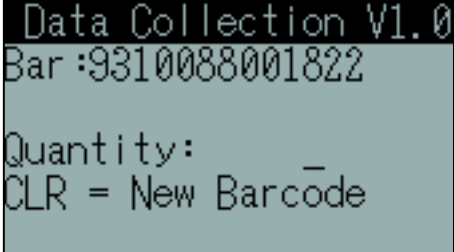

```
Data Collection V1.0
Bar :9310088001822
Quantity:
CLR = New Barcode
```

As an aid to the operator, the barcode that was just scanned or entered is displayed above the **Quantity:** prompt.

The text at the bottom of the screen shows that if the operator just presses the **CLR** key instead of scanning or entering a quantity, the program will go back to the previous **Bar:** prompt so that a new barcode can be entered, discarding the already entered or scanned barcode and not storing it in memory. This would be done if the operator realised they had scanned the wrong barcode, for example.

After the quantity has been scanned or entered, the barcode and quantity are stored as a record in the memory of the Casio DT-930, and the data collection process continues with the operator prompted to scan or enter the next barcode and quantity.

To finish data collection, just press the **CLR** key at each prompt until you get to the **Main Menu**.

## Download Data

To download collected data from the Casio DT-930 to your PC, you need to first ensure that both the Casio Download/Upload utility and the USB drivers are installed and configured – see page 13 for installation details.

You also need to ensure that the Casio Download/Upload utility is running, either open on the screen or minimized to the task bar.

On the DT-930, just select the **2.Download Data** function from the **Main Menu**, which brings up the screen shown on the right.



```
Data Collection V1.0
Data Download
Press 8 to download,
any other key to quit
```

Press the **8** key to start the download – after a few seconds, a progress bar will be displayed on both the PC and on the DT-930, and when the download is complete, the PC will emit a sound and the DT-930 will display the screen shown on the right.

```
Data Collection V1.0
Download
Successful
Press any key
```

When you press a key, the DT-930 will then prompt you to delete the data from the scanner - if you choose not to delete the data, the same data will be transferred again next time you download.

```
Data Collection V1.0
Delete File
Press 8 key to delete
Asp.csv or any other
key to keep
```

The Casio Download/Upload utility stores the data downloaded from the DT-930 into a file called **ASP.CSV** in the **My Documents** folder on your computer. If the file already exists, newly downloaded data will be appended to the existing data.

## Configuration

Select **2.Options** at the Main Menu to enter the Configuration menu, as shown on the right.

```
Configuration
1. Data fields
2. Options
3. Date & time
4. Delete file
```

To select a menu item, press the number key for that item. To return to the **Main Menu**, press the **CLR** key.

### 1. Data fields

The first item on the Configuration menu is **Data Fields** setup, the first screen of which is shown on the right.

```
Location field is now
OFF
0 = Off, 1 = On
Or any other key to
continue
```

On this screen, you can turn the **Location** field **Off** or **On** by pressing the **0** or **1** key, or you can retain the current setting by pressing any other key.

Subsequent configuration screens allow you to similarly turn **Off** or **On** the **Barcode** and **Quantity** fields, and the **Date** and **Time** fields (not pictured).

### 2. Options

The second item on the Configuration menu is **Options** setup, which sets options for the Location and/or Time fields, only if those fields are turned on. If both fields are turned off, the screen on the right is shown.

```
Data Collection V1.0
There are no options
to set with this
configuration
Press any key
```

If the **Location** field is turned on, the **Keep location between scans** option can be set. When this option is turned on, the scanner will only prompt once for the location, and keep that location until the operator decides to change it (by pressing the **ENT** key at the **Bar:** prompt to return to the **Loc:** prompt).

```
Keep Location between
scans is now ON
  0 = Off, 1 = On
or any other key to
continue
```

If the **Time** field is turned on, the **Time with seconds** option can be set. Normally, the time is stored in 24 hour format with hours and minutes only (ie hh:mm). If the **Time with seconds** option is turned on, the seconds will also be stored with the time (ie hh:mm:ss).

```
Include seconds with
time is now ON
  0 = Off, 1 = On
or any other key to
continue
```

### 3. Date & time

The third item on the Configuration menu is the **Date & Time** setting screen, which allows you to set the internal clock in the DT-930.

```
Current Date is
24/09/2008
Enter New Date
dd.mm.yyyy
-
```

At the **Enter New Date** prompt, you can change the date by entering a two digit day of the month, a full stop, a two digit month, a full stop, and a four digit year, followed by the **ENT** key.

If you don't want to change the current date, just press **ENT** by itself to skip to the **Enter New Time** prompt, or **CLR** by itself to return to the Configuration menu.

The **Enter New Time** prompt works in exactly the same way – you can enter a new time, press **ENT** by itself to keep the current time, or press **CLR** by itself to return to the Configuration menu.

```
Current Time is
10:11:14
Enter New Time
hh.mm.ss
-
```

Note that the time must be entered in 24-hour format – for example, 6:13pm would be entered as 18.13.00

### 4. Delete file

The fourth and final item on the Configuration menu allows you to delete the data stored in the DT-930. Press the **8** key to delete the data, or any other key to keep the data. An **"Are you sure"** prompt will then be displayed, and if you confirm that you want to delete the data, it will be permanently deleted.

```
Data Collection V1.0
Delete File
Press 8 key to delete
Asp.csv or any other
key to keep
```

## About

Select **4.About** from the Main Menu to display a screen that shows the program version number and copyright information, and the number of data records currently stored in the scanner.

Press any key to return to the **Main Menu**.



```
ASP Microcomputers
Data Collection V1.0
(C) 2008
Total Records: 42
Press any key
```

## Scanning Barcodes

Ensure that the Casio DT-930 terminal is turned on, and at a place in the program where barcodes can be scanned, then press one of the orange trigger buttons on the sides of the scanner.

Hold the scanner about 3 to 30cm back from the barcode, and direct the red scanning beam onto the barcode as shown on the right. When the barcode has been read successfully, the Casio DT-930 will beep and the indicator LED (above the display) will flash briefly.



If the scanner fails to read the barcode, change the scanning angle or the distance from the barcode, and try it again.

To read barcodes wider than the laser beam width, move the scanner further away from the barcode. The Casio DT-930 can read barcodes at a maximum distance of 45 cm from the reading window, depending on the size and characteristics of the barcode label.

## Keypad Input

In most applications, the only time you'll need to use the keypad is to enter data such as quantities, and these are usually numeric only. The Casio DT-930 was designed to make this kind of data entry fast and simple.

If you need to enter letters or some other characters, the Casio DT-930 has an **Letter input mode**, which is indicated by a small **[S]** at the bottom left of the display, as described on the next page.

To change input modes, you must be at a prompt that allows keypad input. Then, press and release the round **S** key at the top left of the keypad (as shown on the right, above the large **L** key) to change between numbers or letters mode. Each press of the **S** key toggles between numbers and letters, with letter mode indicated by a small **S** at the bottom left of the display.



In numeric mode, the keypad enters the numbers shown on the key. In letter mode, the letters shown in white above each numeric key can be entered. Pressing a key once enters the first letter on the key, pressing a key twice quickly enters the second letter, and so on, similar to a mobile phone keypad. To enter the same key twice, or another letter on the same key, press **ENT** to move the cursor.

To enter a space, press the **F5/SP** key at the bottom left of the keypad. Various punctuation marks can also be entered using the **3**, **0** and **.** keys in letter mode.

## Screen Symbols

Symbols that represent the input mode and battery status are displayed in the bottom section of the display, as shown on the right.

The small **S** on the left indicates letter input mode, while the two symbols on the right indicate the status of the main and backup batteries, as described below.

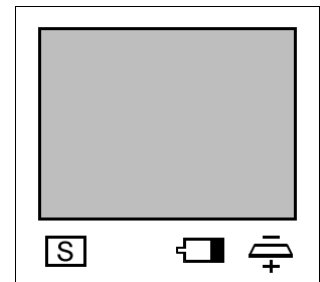

## Low Battery Indicators

Because the Casio DT-930 has two separate batteries, there are low battery indications for each battery. These indicators are displayed at the bottom right of the LCD screen, and appear only when the batteries are low and require attention.



Replace the main battery (or recharge the battery pack) as soon as possible after this low battery icon appears.  
Be sure to **turn the DT-930 off** before you replace the main battery.



When this low backup battery icon appears on the display, immediately replace the backup battery with a CR-2032 lithium battery.  
Be sure to **turn the DT-930 off** before you replace the backup battery.

## Auto Off

The Casio DT-930 is configured to turn itself off after ten minutes of inactivity, to conserve battery power. If the unit powers off, just press the power button to turn it back on – the program will continue from where it was when the unit turned off.

## Display and Keypad Backlight

To make it easier to operate in low-light environments, the Casio DT-930 has a display and keypad backlight. You can turn the backlight on or off by pressing the F8/BL key at the bottom right of the keypad.

The backlight is configured to turn itself off after 15 seconds, to conserve battery power. Pressing any key will turn the backlight on again.

## Casio Download/Upload Utility

The Casio Download/Upload utility (shown on the right) is used to download data from the DT-930 to your PC.

Note that each time you run the Casio Download/Upload utility, you need to go to the **Execute** menu and select **LinkManager**, then click on

**Start Link Manager** before you can receive data from your DT-930.

Once you've done this, you can either leave the program open on your desktop, or you can minimize it. If you close the program, you'll need to open it again and start the **Link Manager** again before you can download.

On the DT-930, select **Download Data** from the **Main Menu**, to display the screen shown on the right.

Press the 8 key to start the download – after a few seconds, a progress bar will be displayed on both the PC and on the DT-930, and when the download is complete, the PC will emit a sound and the DT-930 will display the screen shown on the right.

When you press a key, the DT-930 will then prompt you to delete the data from the scanner - if you choose not to delete the data, the same data will be transferred again next time you download.

The Casio Download/Upload utility stores the data downloaded from the DT-930 into a file called **ASP.CSV** in the **My Documents** folder on your computer. If the file already exists, newly downloaded data will be appended to the existing data.

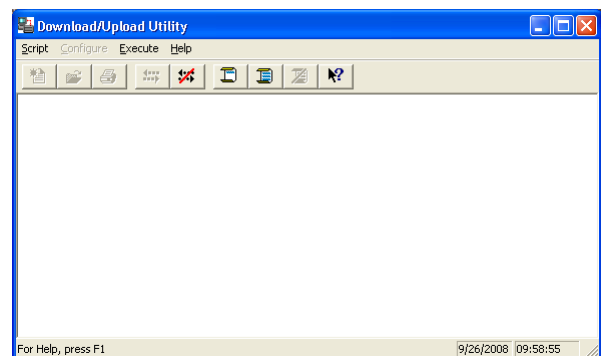

```
Data Collection V1.0
Data Download
Press 8 to download,
any other key to quit
```

```
Data Collection V1.0
Download
Successful
Press any key
```

```
Data Collection V1.0
Delete File
Press 8 key to delete
ASP.csv or any other
key to keep
```

## Troubleshooting Data Download

If you're having trouble downloading data from the DT-930 to your PC, the first thing you should check is the indicator lights on the front of the cradle – both should be green.

**If the POWER indicator is red**, it means that the DT-930 is not properly inserted into the cradle.

**If the POWER indicator is not lit**, it means that the cradle is not connected to power, or it's not turned on.

**If the LINE indicator is not lit**, it means that the USB cable is not connected to the cradle, or not connected to the PC.

On your PC, down near the clock at the bottom right of your screen, there should be a **little green and grey USB icon**, as shown on the right. If you click your left mouse button while the cursor is on this icon, the message on the right should be displayed, confirming that the USB drivers are installed. Click somewhere other than the message to remove the message from your screen.

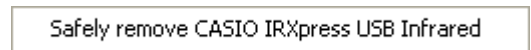

On your PC, click on the **Configure** menu at the top of the program, and ensure that the **B.S/B.B(IOBOX)** entry is ticked, as shown on the right. If it's not ticked, tick it, and then click on **Set As Default** to save the setting.

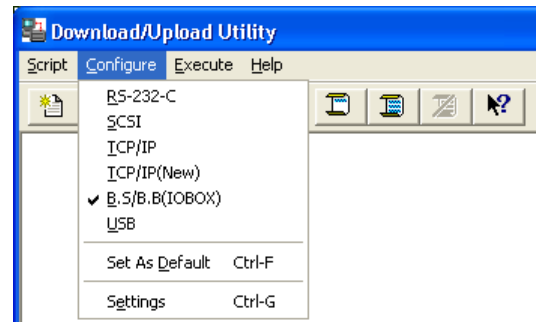

Still on your PC, click on the **Execute** menu and select **LinkManager - Start Link Manager** should be greyed out, which means that the Link Manager is running. If it isn't, click on **Start Link Manager** to start it, as shown on the right.

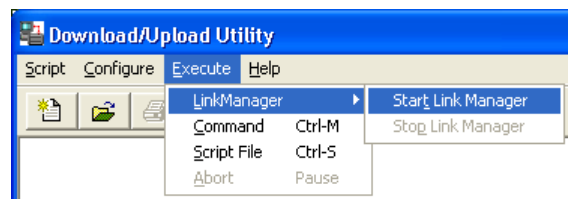

## Installing the Download/Upload Utility and Drivers

The Casio DT-930 installation CD contains two folders, and is not an auto-run installer. This is because the Casio Download/Upload utility and the USB drivers are separate programs and cannot be installed automatically.



The programs on the CD must be installed in the correct order – first the Casio Download/Upload utility, then the IRXPress USB drivers.

To install the **Casio Download/Upload utility**, open the **LMWIN700** folder on the CD (as shown below) and run the **setup** program in that folder.



Then, follow the on-screen instructions, accepting all of the defaults.

To install the IRXPress USB drivers, open the **IRXPress-USB** folder on the CD (as shown below) and run the **SetupUSBIrDA** program in that folder.



Again, follow the on-screen instructions, accepting all of the defaults.

When the IRXPress USB driver installation is finished, you will be asked to reboot your computer – you need to do this or the programs will not work correctly.

After your PC has rebooted, plug in the cradle's power supply, turn it on, and connect the cradle to a free USB port on your PC. Then, follow the instructions on the next few pages.

Note that the following instructions and screen images are for Windows XP – the steps are very similar for Windows Vista.



Your PC will now let you know that it's detected a new USB device.

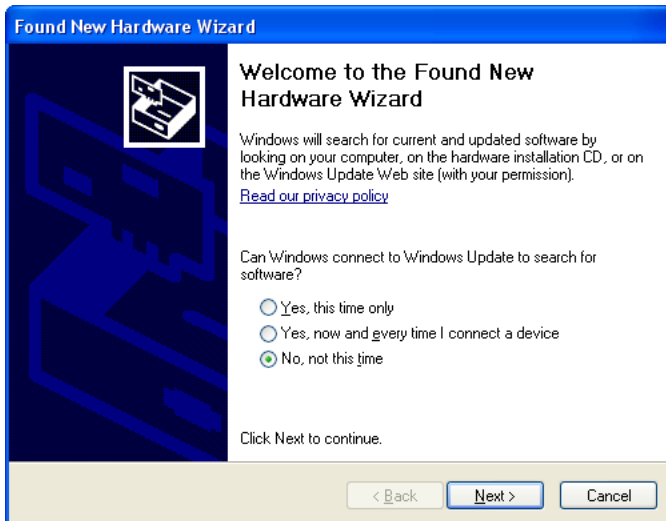

When the Found New Hardware Wizard opens, select the “**No, not this time**” option, because we’ve already loaded the drivers onto your PC. Click on the **Next** button to continue.

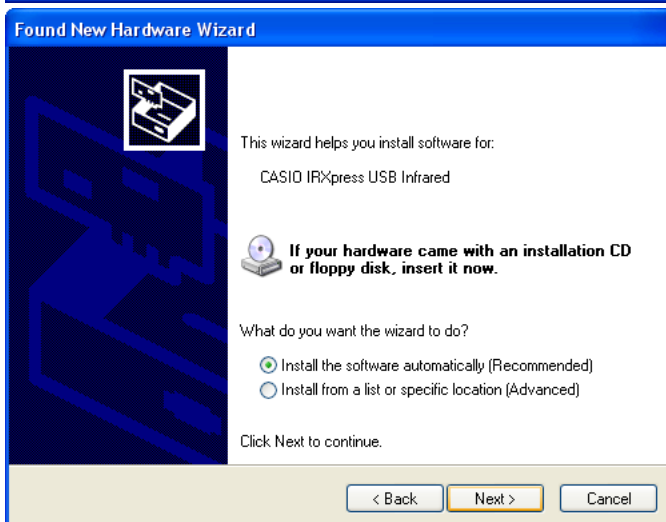

Next, the Found New Hardware Wizard will let you know that it's identified the new USB device (it's a **CASIO IRXpress USB Infrared** device), and offer to automatically install the software, which we want it to do. Click on the **Next** button to continue.

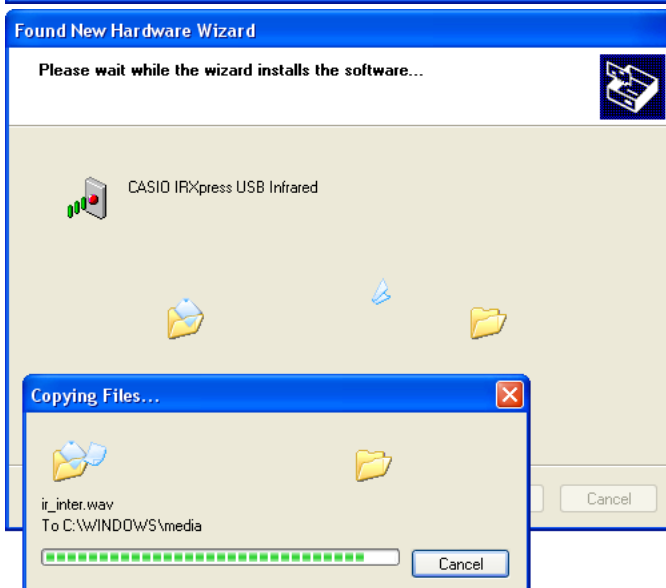

Windows will now install everything that it needs.



Eventually, the New Hardware Wizard will finish installing the software and display this window. Click on the **Finish** button.

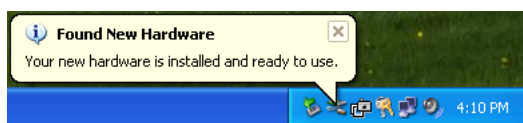

Finally, Windows will tell us that the new hardware is ready to use.

All of the software and drivers are now installed. However, before you can use the Download/Upload utility, you need to run it and configure it.

Go to your computer's **Start Menu**, select **All Programs**, and then click on the **CASIO LMWIN32** program entry to run the Download/Upload utility.

Click on the **Configure** menu at the top of the program, then click on the **B.S/B.B(IOBOX)** entry, as shown on the right. The menu will then close, so open it again and make sure that the **B.S/B.B(IOBOX)** entry is ticked. If not, try again.

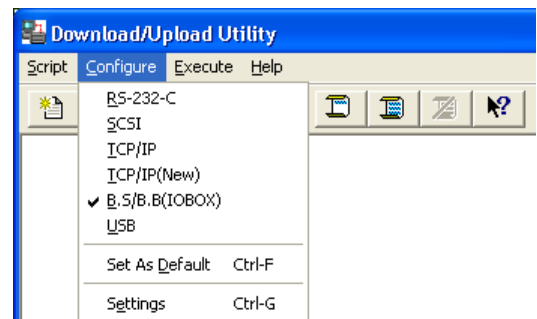

If the **B.S/B.B(IOBOX)** entry is ticked, click on the Download/Upload utility entry to save the configuration. You won't need to set this option again after this step.

Finally, click on the **Execute** menu at the top of the program, then click on the **LinkManager** entry, then click on **Start Link Manager**, as shown on the right. The

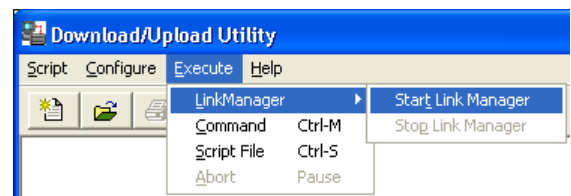

Download/Upload utility is now ready to receive data from your DT-930. Note that you need to perform this step each time you run the Download/Upload utility.

See page 11 for information on using this program.

## Copyright, License, and Limited Warranty

### Casio DT-930 Scanner and Cradle

To the extent permitted by law, ASP's warranty in respect of the **Casio DT-930 Scanner and Cradle** and its use is limited to correction of defects due to faulty components or workmanship for a period of one year from the date of purchase. This warranty does not extend to consumables such as batteries, and does not cover wear and tear to products.

This warranty is in lieu of other warranties express or implied including but not limited to the implied warranties of merchantability and fitness for purpose. In no event will ASP Microcomputers be liable for damages including loss of profits or other consequential damages arising out of use or inability to use the products.

This limited warranty gives you specific legal rights. Some states give other rights and/or do not allow excluding or limiting implied warranties or limiting liability for consequential damages. Accordingly, the above limitations/exclusions may not apply to you. If any provision of this agreement shall be void unlawful or unenforceable then that provision shall be severable without affecting the validity of remaining provisions. This agreement is governed by the law of Victoria, Australia.

It is your responsibility to carefully pack any unit being returned for service, warranty or otherwise, and pay shipping charges to your dealer location or ASP. Units sent freight collect will not be accepted. Freight back to you will be paid by ASP in the case of warranty repairs.

### Casio Download/Upload utility and Standard Program

The **Casio Download/Upload utility** and the **Standard Casio DT-930 program** are proprietary products of ASP Microcomputers and are protected by copyright laws, which prohibit making additional copies of the software for any other person.

ASP Microcomputers grants the purchaser of the **Casio Download/Upload utility** and the **Standard Casio DT-930 program** a license to use the software with the **Casio DT-930 Scanner and Cradle**, but not to sub-license, rent or lease the software. You may permanently transfer your license to use the software by passing the original disk or CD and manual to another person and simultaneously destroying all copies of the software or documentation in your possession. Such a transfer terminates your license to use the software, and the new possessor of the software accepts a license to use the software on the basis expressed here on first use of the software.

ASP Microcomputers undertakes that the **Casio Download/Upload utility** and the **Standard Casio DT-930 program** will perform substantially as described in this manual, and will correct "bugs" in the software reported to us by licensed users within a reasonable time. Should such "bugs" not be correctable, the only remedy available will be return of the software for refund.

This warranty is in lieu of other warranties express or implied including but not limited to the implied warranties of merchantability and fitness for purpose. In no event will ASP Microcomputers be liable for damages including loss of profits or other consequential damages arising out of use or inability to use the software.

This limited warranty gives you specific legal rights. Some states give other rights and/or do not allow excluding or limiting implied warranties or limiting liability for consequential damages. Accordingly, the above limitations/exclusions may not apply to you. If any provision of this agreement shall be void unlawful or unenforceable then that provision shall be severable without affecting the validity of remaining provisions. This agreement is governed by the law of Victoria, Australia.